

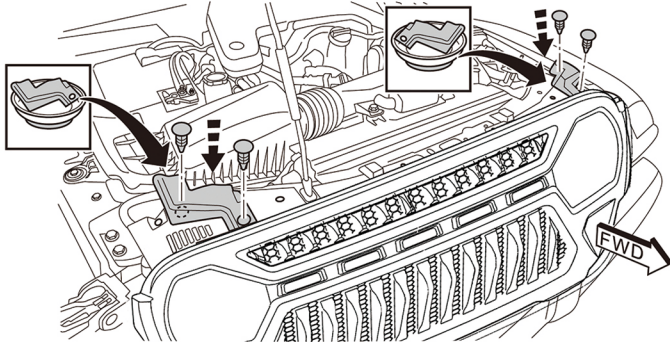

OVERTREAD

# Mojave Grill Part # 19033 Install Instructions

7



1

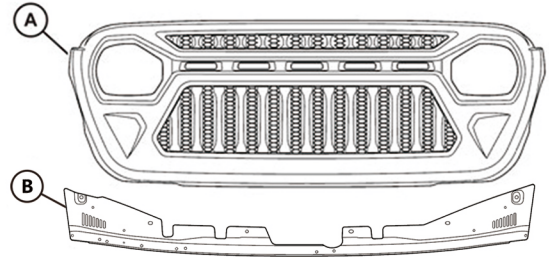

8

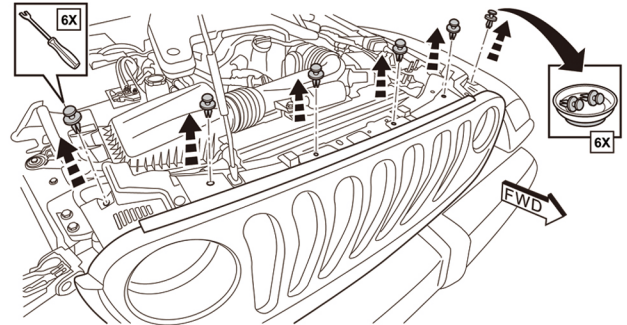
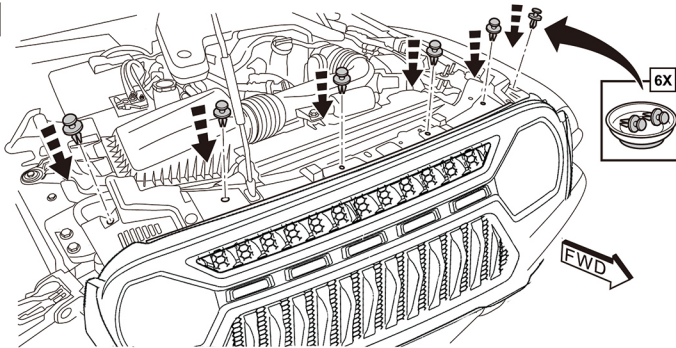

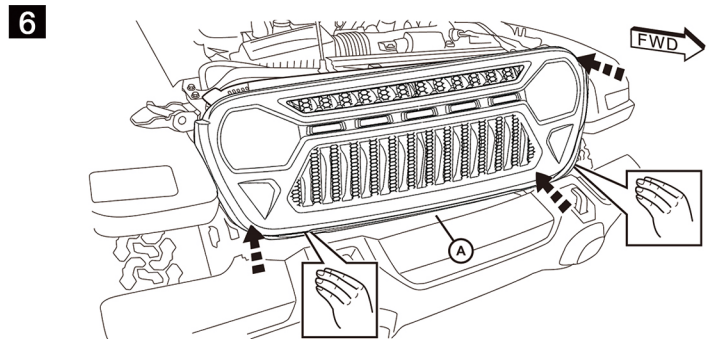
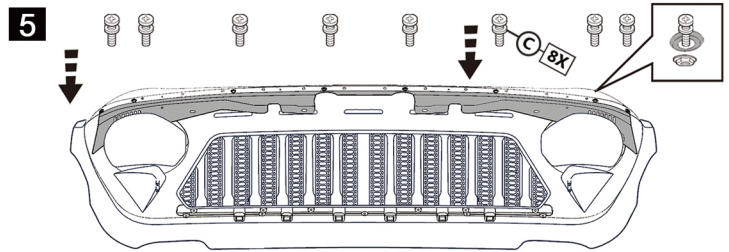
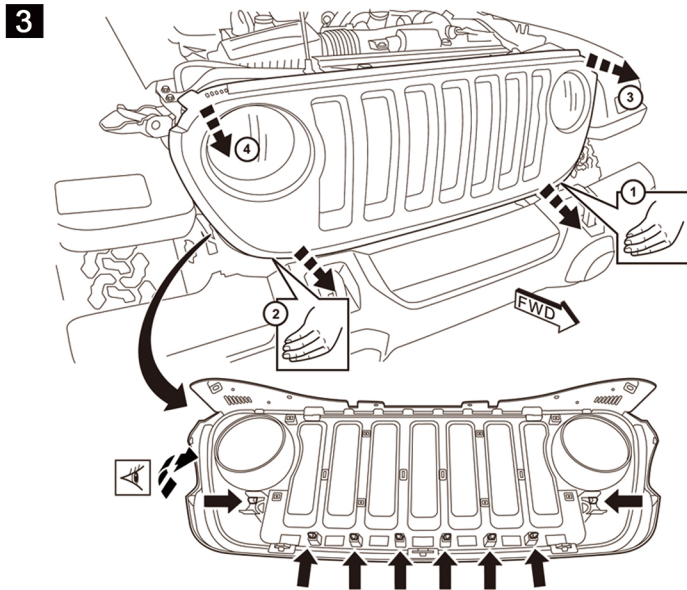
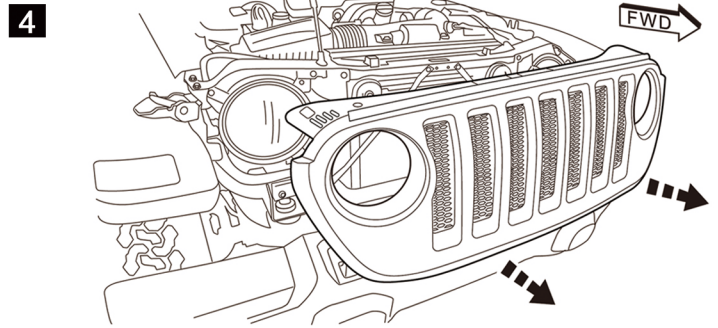
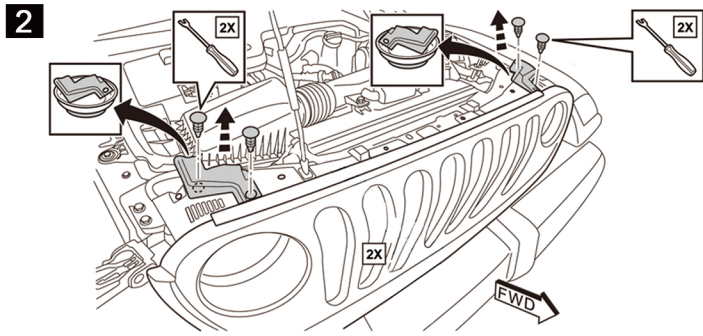



**OVERTREAD**

**Overtread 18-20 Jeep Wrangler  
JL / Gladiator Mojave 19033  
Install**

**Please take time to read and understand these installation instructions. 19033**

Overtread recommends that the installation be performed by a qualified service center or professional installer who has the necessary equipment, tools and experienced personnel. However, if you decide to perform this install the use of an additional person may be required.

**CAUTION:** Never work on a hot engine bay. Allow time for the vehicle to cool.

**Recommended Tools:**

- Flathead Screwdriver or Fastener Remover
- Assorted Socket-Set
- Wire Cutters
- Pliers
- Ratchet
- Ratchet Extension

**Please confirm that all parts are present before beginning the installation.**

Bill of Materials							
1	Grill	1	Wire Harness	8	Clips	8	Bolt, Washers and Nuts





**Installation instructions to turn marker lights on when running lights or headlights are turned on**



Remove the 2 bolts with an 8mm Socket and the retainer clip.



Pull back the inner fender liner and turn the turn signal socket connection counterclockwise to pull away from the housing



Use a splice snap clip to splice into the white and orange wire.



insert the RED grill harness wire into the clip and clamp.



Connect grill ground wire to chassis behind passenger side headlight.



## Installation Instruction to keep marker lights on when the vehicle is turned on.

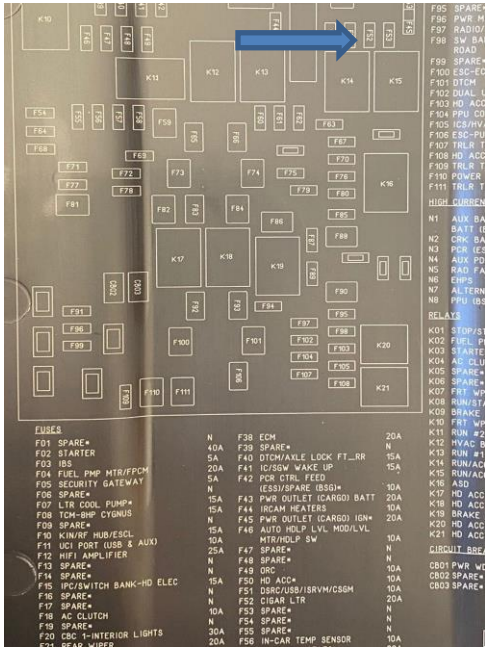

Remove the fuse box lid and pull number F52 fuse out using the stock fuse puller.

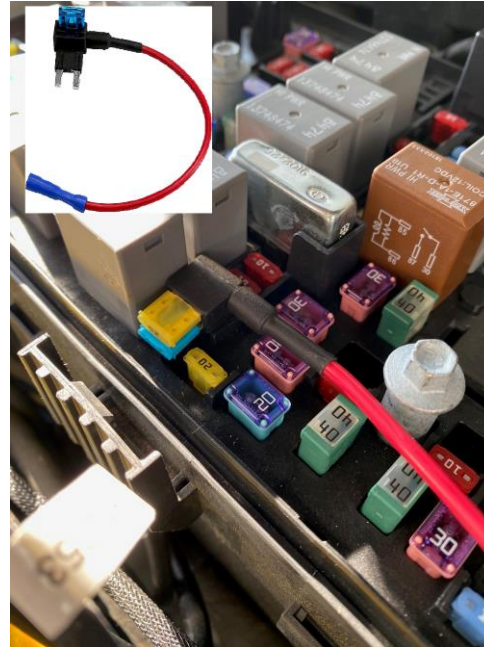

Connect the grill wire first to the micro2 fuse tap adapter and insert it into the F52 fuse location.